



# Prisma II 2.5 Gb/s 4:1 bdr Product Design Application Note

## Introduction

Prisma II™ bdr™ products transfer broadband RF through the reverse path of an HFC network via a digital optical link. A transmitter component converts up to four separate reverse analog RF signals to a single digital data stream that flows through the optical link to a receiver component. The receiver then converts the digital data stream back to the individual analog RF signals.

This application note describes artifacts that may appear in the output of Prisma II 2.5 Gb/s 4:1 bdr products and the possible impact of these artifacts on system performance. It also describes aspects of the 2.5 Gb/s 4:1 bdr product design that are responsible for creating these artifacts. This information is intended for designers of HFC networks that incorporate 2.5 Gb/s 4:1 bdr products, and for service technicians who analyze and troubleshoot 2.5 Gb/s 4:1 bdr products in the field.

**Note:** This Design Application Note is subject to change without notice.

## In This Document

■ Basic Sampling Theory.....	2
■ Sampling and the bdr Product.....	9
■ Conversion Artifacts.....	18
■ Conclusion.....	23
■ For Information.....	24

## Basic Sampling Theory

The concept of analog-to-digital and digital-to-analog conversion has been well understood for some time. In the most basic approach, an analog-to-digital converter (A/D) samples an analog voltage waveform at regular intervals. These intervals are known as the sampling period ( $T_s$ ) and the inverse of the sampling period is known as the sampling frequency ( $F_s$ ).

The A/D outputs a number (digital word) at each sample period that is linearly proportional to the amplitude of the analog voltage waveform during that sample period. A series of these digital words can be used to represent variations in the analog voltage waveform over time.

A digital-to-analog converter (D/A) takes a digital word as an input and outputs an analog voltage that is linearly proportional to the value of the digital word. If the series of digital words generated during A/D conversion is applied to the input of the D/A at the same rate as the sample frequency used by the A/D to create them, the output from the D/A will closely approximate the original analog waveform.

### Quantization Noise

Certain artifacts may appear in the recreated waveform as a result of the conversion process. One such artifact results from the fact that the A/D and D/A do not have infinite precision. At each sampling of the analog waveform, the A/D generates a digital word that best matches the value of the input voltage. There will usually be a small difference between the value of the input voltage and the output digital word. This difference is known as quantization error.

The figure below shows a typical analog-to-digital-to-analog (A/D-D/A) voltage transfer characteristic illustrating the effect of the digitization and reconstruction process.

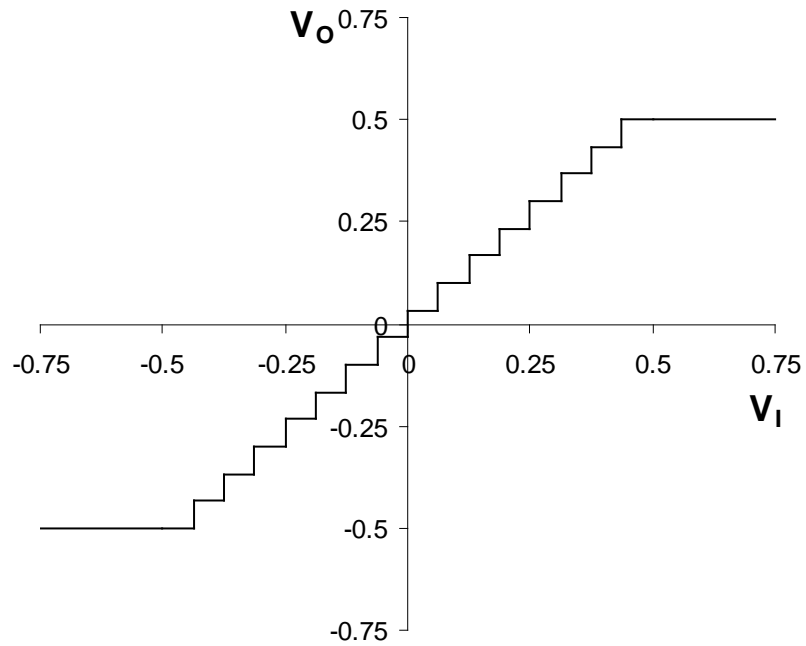

$V_i$  is the input voltage to the process and  $V_o$  is the output voltage from the process. The digitization converts the continuous input analog voltage to a series of discrete voltage steps or quanta at the output. The difference between the input voltage and the reconstructed output voltage is known as quantization noise. Note that, above a certain input voltage level, the output voltage is hard limited to a fixed level (clips).

## Basic Sampling Theory

The figure below illustrates the amplitude of the quantization error voltage as a function of input voltage.

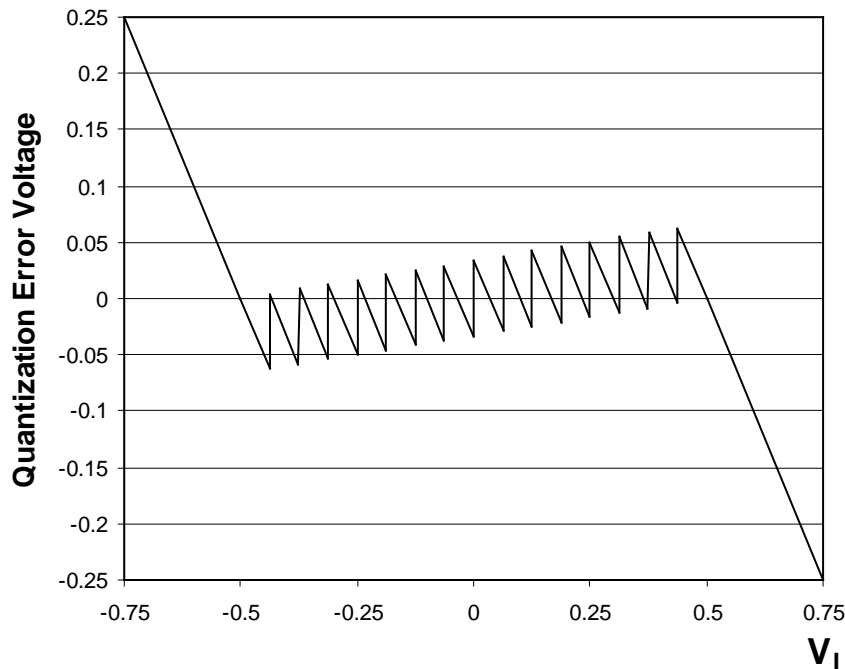

As long as the input signal remains below the clipping threshold, quantization noise usually appears in the output frequency spectrum as a broadband noise floor that has constant power per unit frequency (white noise).

Typical A/D converters produce the digital output word in binary format. The greater the number of bits in this digital output word, the greater the accuracy of the analog-to-digital conversion. Accuracy improves because, as the number of bits increases, the step size in the voltage transfer characteristic decreases. This causes quantization noise to decrease, and the noise floor to drop.

## Aliases

A second artifact that results from the conversion process is a function of the sampling frequency. Because the A/D-D/A conversion process is inherently nonlinear, artifacts appear in the reconstructed signal in the frequency domain. These artifacts, known as aliases, are similar to undesired images produced by analog mixers.

Nyquist has *shown*<sup>1</sup> that, for accurate reconstruction of an analog waveform following A/D-D/A conversion, the waveform must be sampled at a frequency that is at least twice that of the analog bandwidth. This requirement is known as the Nyquist sampling criterion. For example, if a waveform to be sampled contains energy from DC up to a maximum frequency  $F_{MAX}$ , it must be sampled at a frequency  $F_s$  that is at least  $2 \times F_{MAX}$ . One-half of the sampling frequency  $F_s$  is also known as the Nyquist frequency ( $F_{NYQUIST}$ ).

Sampling frequencies are typically chosen to be slightly greater than  $2 \times F_{MAX}$  to allow for practical considerations. Therefore, the input signal must have a bandwidth of somewhat less than half the sampling frequency. If the bandwidth of the input signal is not strictly limited to less than half the sampling frequency, undesired versions of the input frequency spectrum will be created by the digitization process. These undesired versions, or aliases, are "mirrored" around the Nyquist frequency.

---

<sup>1</sup> H. Nyquist, "Certain topics in telegraph transmission theory," Trans. AIEE, vol. 47, pp. 617-644, Apr. 1928 (reprinted in Proc. IEEE, Vol. 90, No. 2, Feb 2002).

## Basic Sampling Theory

The figure below illustrates the aliases created by the A/D-D/A conversion process.

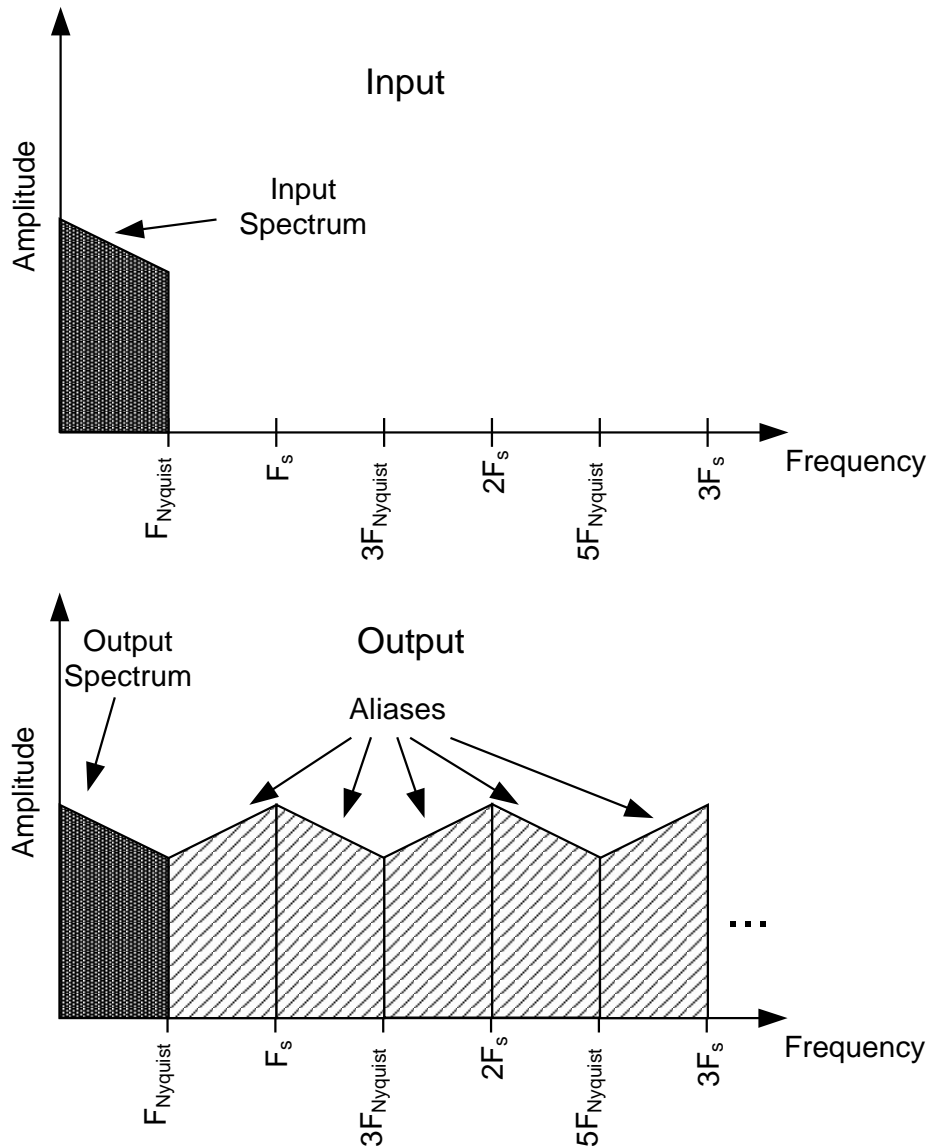

The upper plot indicates the input spectrum, while the lower plot indicates the output spectrum. Note that the output spectrum contains the input spectrum at frequencies from DC to  $F_{NYQUIST}$  and a mirrored frequency image of the input signal at frequencies between  $F_{NYQUIST}$  and  $F_s$ . This mirrored image of the input spectrum is known as the first alias. Similarly, additional copies or aliases of the input spectrum, both normal and mirrored (inverted), extend in frequency above  $F_s$ .

These aliases typically roll off in amplitude with increasing frequency. The exact rolloff characteristics are a function of the particular D/A used in the reconstruction process. In the case of a stair-step approximation D/A, the aliases rolloff following a  $\sin(f)/f$  frequency response.

An unfortunate consequence of the Nyquist sampling criterion is that signals applied to the input of the A/D at frequencies other than the band from DC to  $F_{\text{NYQUIST}}$  will produce undesired outputs and aliases.

The figure below illustrates the consequences of undesired signals applied to the A/D input.

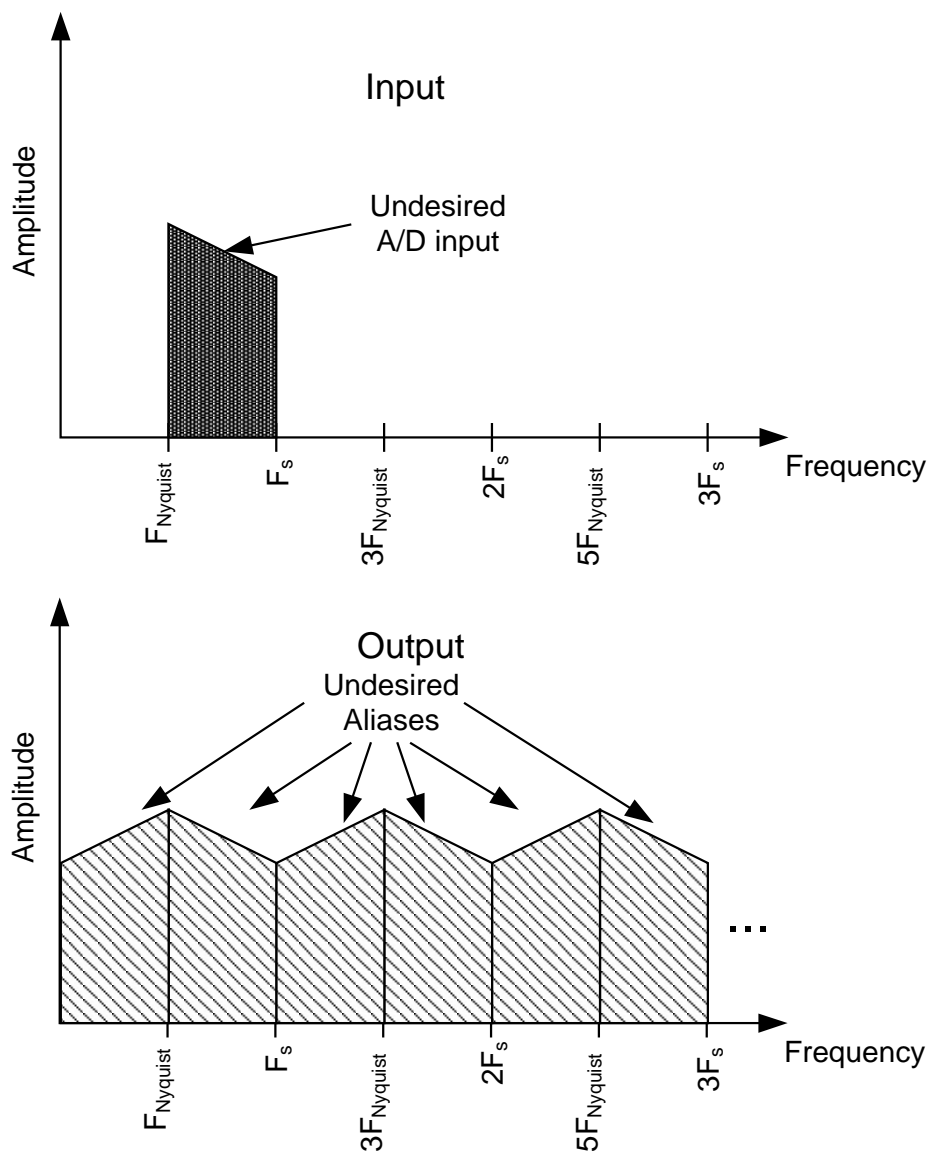

In this example, a band of signals between  $F_{\text{NYQUIST}}$  and  $F_s$  is applied to the A/D input. This produces aliases as shown, including signals in the band from DC to  $F_{\text{NYQUIST}}$ . If desired signals are now applied to the A/D in the band from DC to  $F_{\text{NYQUIST}}$ , they will be corrupted at the output by the alias of the undesired signals applied to the input in the band between  $F_{\text{NYQUIST}}$  and  $F_s$ .

## Basic Sampling Theory

Therefore, care must be taken to ensure that out-of-band signals are not applied to the A/D input. In such cases, aliases might be produced that will interfere with the desired output in the band of interest.



## Sampling and the bdr Product

The Cisco bdr product line uses high-speed A/D and D/A circuits to convert the broadband reverse RF signals in an HFC reverse path into digital words for transmission over a digital optical link.

### Sampling and the 2.5 Gb/s 2:1 bdr Product

In the 2.5 Gb/s 2:1 bdr products, a pair of high-speed 12-bit A/D converters digitizes the reverse RF signals on the transmit end. A 2.5 Gb/s digital optical link transports the digital words to a pair of high-speed 12-bit D/A converters on the receive end, which reconstructs the reverse RF signals.

Each A/D converter on the transmit end has its own RF input. This permits two separate reverse path spectra to be sampled. The A/D converters operate at a sample frequency ( $F_s$ ) of 100 MHz. Consequently, each converter has a Nyquist frequency ( $F_{\text{NYQUIST}}$ ) of 50 MHz. The Nyquist sampling criterion indicates that signals from DC to 50 MHz may be accurately sampled and reconstructed. In the case of the 2.5 Gb/s 2:1 bdr product, the band of signals of interest are limited to the 5 MHz to 42 MHz band.

The figure below contains a simplified block diagram of a 2.5 Gb/s 2:1 bdr link.

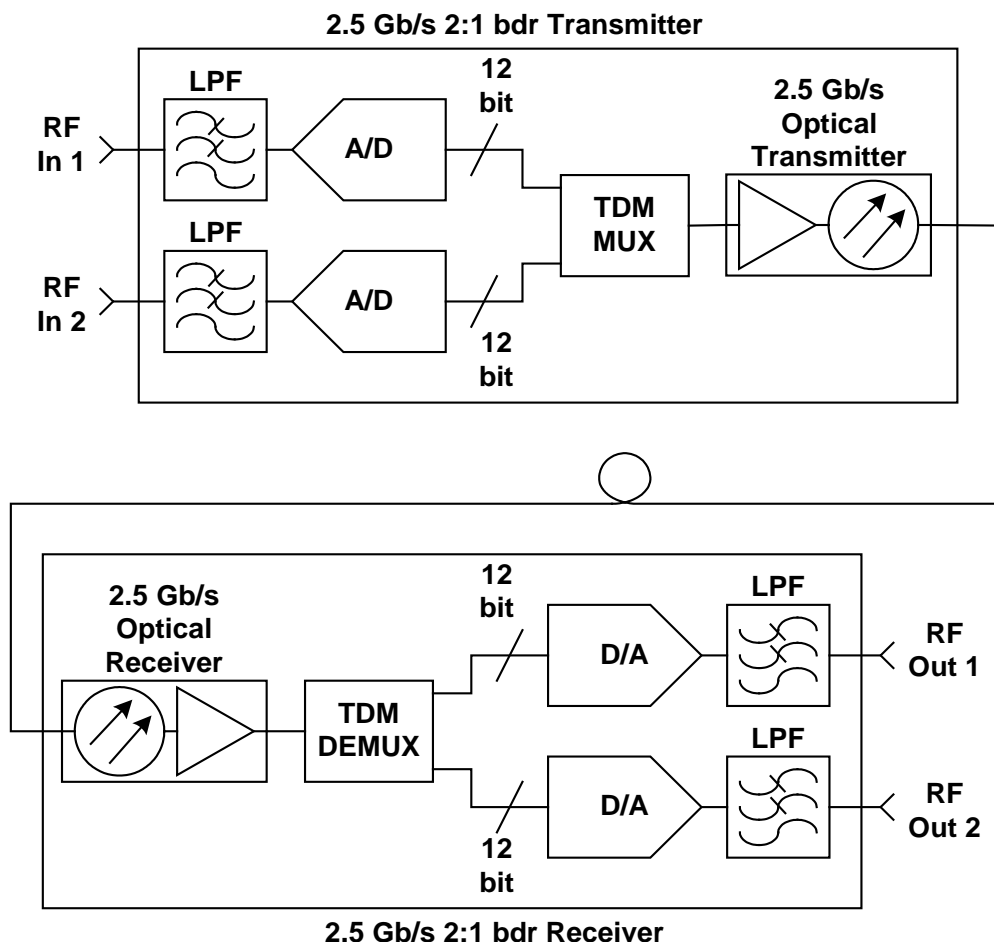

Each 12-bit A/D converter, operating at a sample frequency of 100 MHz, produces 1.2 Gb/s. The two 1.2 Gb/s data streams are multiplexed together and combined with framing overhead to create the 2.5 Gb/s data stream for the optical link. The 2.5 Gb/s data is recovered and demultiplexed at the receiver to provide 12-bit words at a 100 MHz rate for the two D/A converters.

Based on the sampling and Nyquist frequencies mentioned above, any signals at the input to the A/D converters in the range of 58-95 MHz, 105-142 MHz, 158-195 MHz, etc. would create aliases in the 5-42 MHz band that would corrupt the desired signals in that band. Low-pass filters on the transmitter front end pass signals below 42 MHz, but attenuate signals above 58 MHz well enough to avoid creating undesirable aliases. Similarly, low-pass filters after the D/A converters in the receiver are provided to pass signals in the 5-42 MHz band while attenuating any aliases created by those signals at frequencies above 58 MHz.

## Sampling and the 2.5 Gb/s 4:1 bdr Product

Direct extension of the techniques used in the 2.5 Gb/s 2:1 bdr product does not give adequate results for a 4:1 product. Four 12-bit A/D converters operating at a sample rate of 100 MHz produce an aggregate data rate of 4.8 Gb/s. This exceeds the data rate available in the 2.5 Gb/s optical link. Reducing the sample frequency to 50 MHz in order to reduce the data rate would not provide adequate RF bandwidth for the four RF inputs. Reducing the resolution (number of bits) of the A/D converter to 6 bits would not provide adequate dynamic range for the four inputs, as measured by noise power ratio (NPR) testing.

This problem is solved in the 2.5 Gb/s 4:1 bdr product through the use of two clever techniques: digital down-conversion and digital companding. Digital down-conversion shifts a signal to a lower frequency range so that it can be accurately digitized using a lower sampling frequency. Digital companding uses a nonlinear transfer characteristic that can encode the signal with fewer bits.

The figure below contains a simplified block diagram of a 2.5 Gb/s 4:1 bdr link. Digital down-conversion and digital companding are performed in the blocks labeled Digital Signal Processing and TDM MUX (transmitter) and in the Digital Signal Processing and TDM DEMUX (receiver).

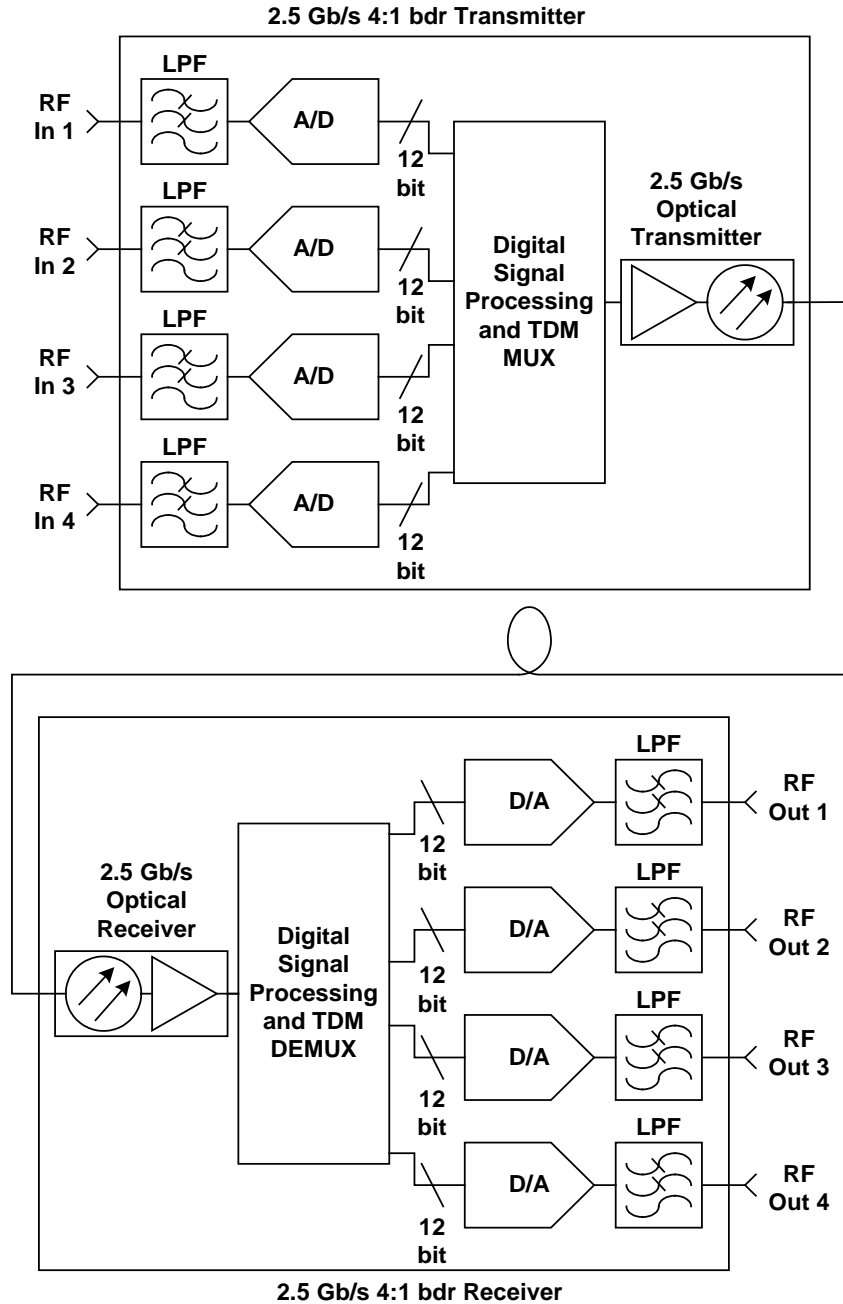

## Digital Down-Conversion

After digitization of each RF input signal at the transmitter, the signals are processed in the digital domain. Digital down-conversion effectively mixes the input frequency band down to a lower group of frequencies.

In all versions of the 2.5 Gb/s 4:1 bdr product (5-40 MHz, 7-42 MHz, and 10-45 MHz), the input band is digitally mixed down to the range 2-37 MHz. The signals are then digitally resampled at 75 MHz, reducing the data rate for each reverse path spectrum from 1.2 Gb/s to 900 Mb/s.

At the receive end, a digital up-conversion is performed to restore each reverse path spectrum to its original frequency band of 5-40 MHz, 7-42 MHz, or 10-45 MHz.

While the digital down-conversion reduces the bit rate required for each reverse path spectrum, the aggregate bit rate for all four spectra is 3.6 Gb/s. This is still too large for the 2.5 Gb/s optical link, so digital companding is used to further reduce the aggregate bit rate.

## Digital Companding

Companding (a shortened form of the words “compress” and “expand”) is a technique by which the dynamic range of a link may be increased. Consider an analog link of the form shown in the block diagram below.

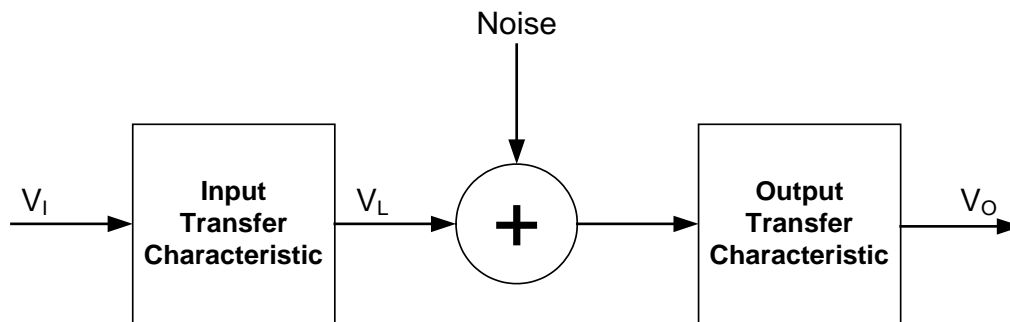

$V_I$  represents the signal at the input to the link.  $V_L$  represents the desired signal inside the link. It is assumed that noise is added to the signal as it passes through the link.  $V_O$  represents the signal plus noise at the output of the link.

Sampling and the bdr Product

At the input side of the link, a transfer characteristic similar to that shown in the figure below is employed.

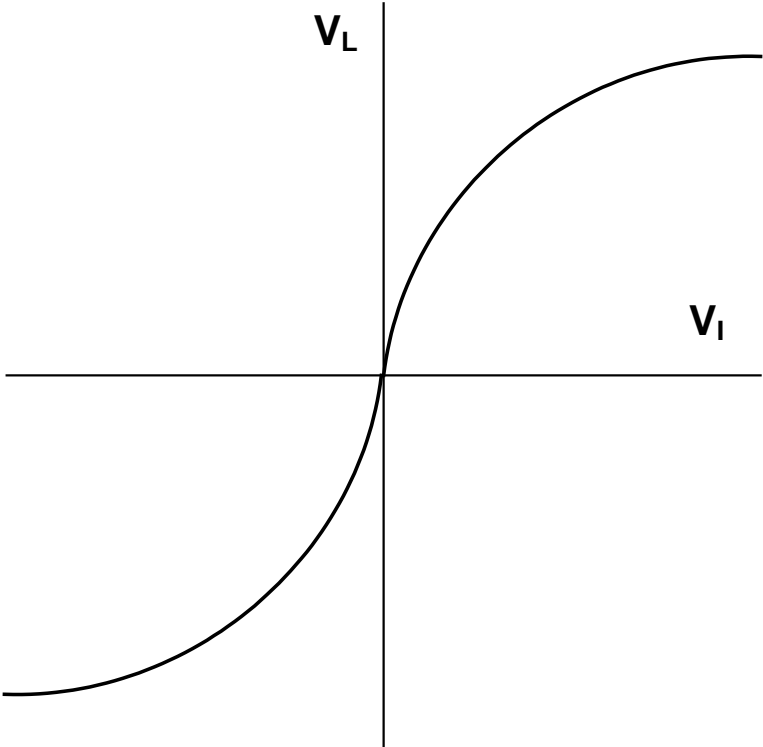

The slope of the transfer characteristic, and hence the gain, is high for small input signals. As the signal amplitude increases, the transfer characteristic flattens out, indicating reduced gain.

At the output side of the link, a transfer characteristic that is the inverse of that shown in the figure above is employed. The output transfer characteristic is shown below.

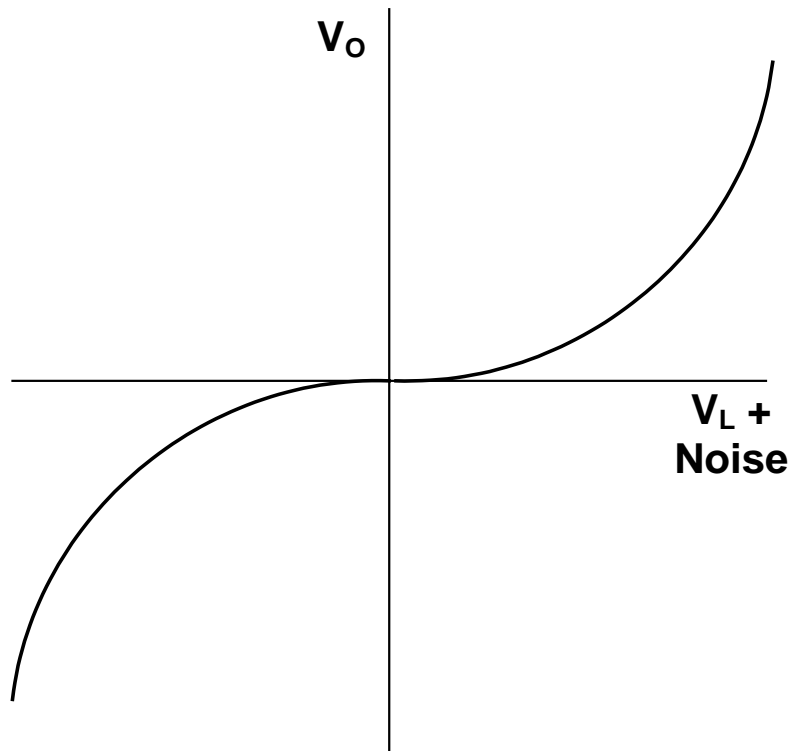

Because the output transfer characteristic is the inverse of the input transfer characteristic, signals that pass through the link experience unity gain. Consider, however, what happens to any noise added inside the link. When  $V_L + \text{noise}$  is small, the output gain is low, and the noise at the link output is attenuated. As  $V_L + \text{noise}$  increases in amplitude, the gain is increased, and the noise at the link output increases.

As a result, the link appears to contribute only a small amount of noise to small input signals, while for large input signals, the noise contribution from the link is greater. The increased noise for large input signals is generally tolerated because the ratio of signal to quantization noise remains relatively high.

The technique just described may be applied to systems that digitize analog signals. A digital companding system digitizes with high resolution (small step size) for small input signals, and uses progressively larger step sizes as signal swing (amplitude) increases.

## Sampling and the bdr Product

A sample transfer characteristic for digital companding is illustrated below.

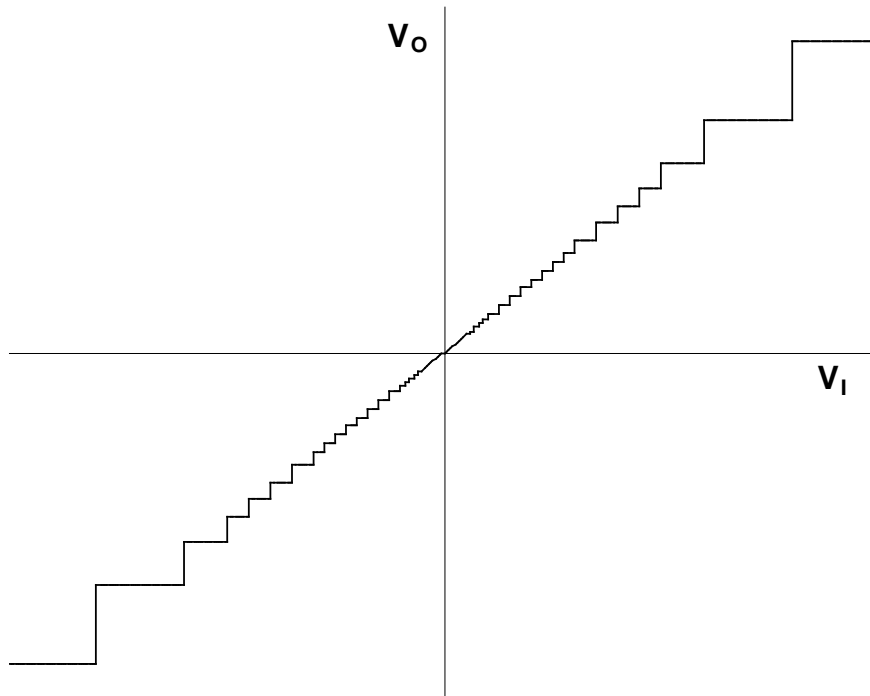

This characteristic represents the entire link (input  $V_i$  to output  $V_o$ ). Small input signals are digitized with small step sizes and, consequently, small amounts of quantization noise. However, as the signal swing increases, the step size and resulting quantization noise also increase.

If the step size used for small signals were maintained over the entire input range, the number of output states would be increased from that shown in the figure above. However, at the extremes of input signal voltage range, the output step size becomes larger. Consequently, the number of bits required to represent the total number of output states is smaller than would be needed if the small output step size were maintained over the entire input full-scale range.

Consider, for example, a companded system in which the step size for small signals was  $1/4096$  of the input full-scale range. If this step size were maintained over the entire dynamic range, 12 bits would be needed to represent all of the possible states. However, if the step size were increased for large signal swings such that only 256 possible output states existed, only 8 bits would be needed to represent all output states. For small signals, the output signal to quantization noise would be equivalent to that in a 12-bit system. For large signals that could tolerate more noise, the quantization noise would increase. Hence, performance approaching that of a 12-bit system would be obtained using only 8 bits.



The 2.5 Gb/s 4:1 bdr product uses the digital companding technique just described to reduce the number of bits required for each digital word from 12 bits to 8 bits. This further reduces the required link data rate so that each 5-40 MHz spectrum, after digital down-conversion and digital companding, requires only 600 Mb/s. The resulting aggregate data rate of 2.4 Gb/s, when added to framing and overhead bits, is small enough to fit in the available bandwidth of the 2.5 Gb/s optical link.

## Conversion Artifacts

As mentioned above, the digital signal processing (DSP) in the 2.5 Gb/s 4:1 bdr products produces a Nyquist frequency just 0.5 MHz above the passband of interest. In the 5-40 MHz version of the 2.5 Gb/s 4:1 bdr product, this is reflected in the output after digital up-conversion as an effective Nyquist frequency of 40.5 MHz. Consequently, signals in the reverse path spectrum will produce aliases in the output with respect to this frequency. These aliases appear as images of the desired signals mirrored around 40.5 MHz.

In the receiver, a low-pass filter after each D/A converter rolls off these aliases with increasing frequency. However, a few aliased signals may appear in the range from 41 to approximately 47 MHz when input signals are applied at the transmitter in the range of 34-40 MHz. These aliases do not represent any additional loading of the bdr link, and generally are insignificant artifacts of the DSP process.

## Artifacts from Digital Down-Conversion

The figure below illustrates aliases resulting from down-conversion of desired inputs. Note that the aliases decrease in amplitude with increasing frequency. This is due to the rolloff of the low pass filter in the receiver output.

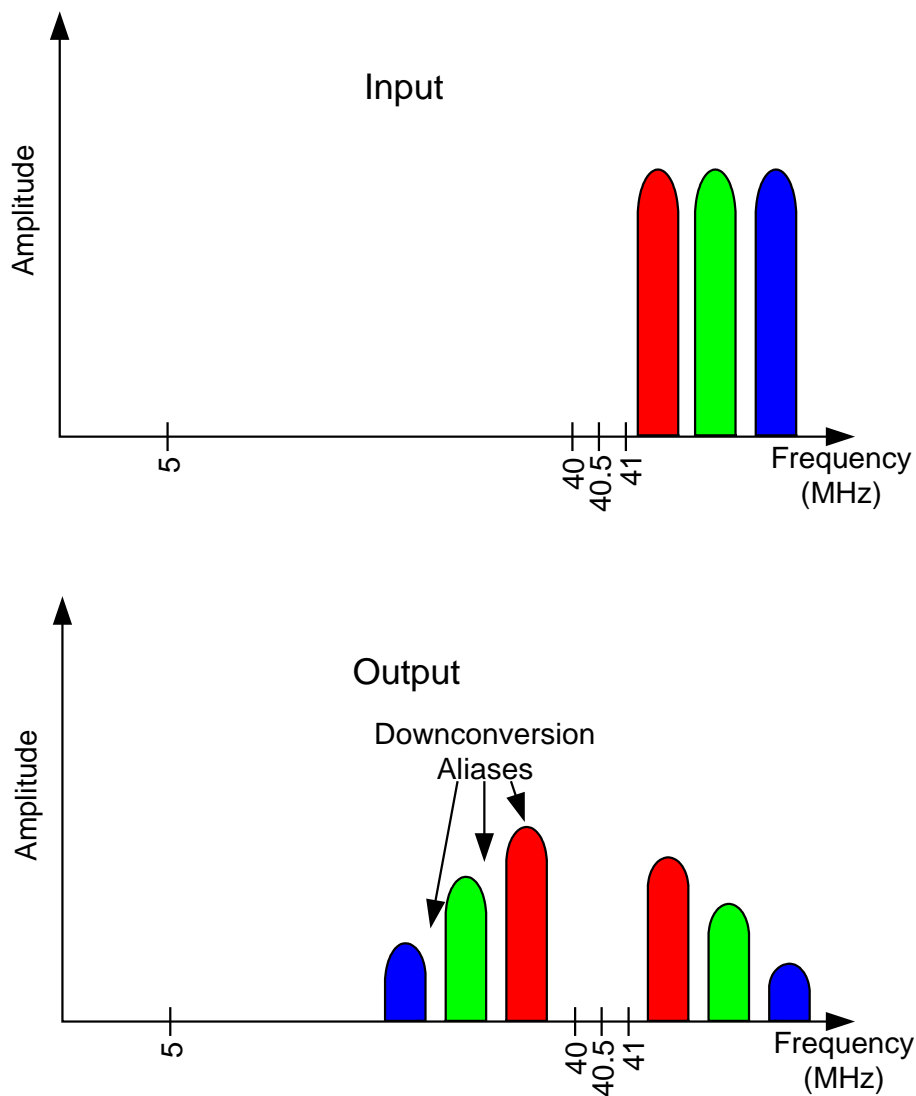

Note that, in the case of the 7-42 MHz and 10-45 MHz versions of the 2.5 Gb/s 4:1 bdr product, these aliases will appear at the output in the 43-49 MHz and 47-52 MHz bands, respectively.

A similar artifact results if signals are applied to the transmitter input in the frequency range from 41 to approximately 47 MHz. If such signals are present, aliases may be generated in the range from 34-40 MHz that might corrupt the desired signals in that band.

## Conversion Artifacts

This phenomenon is illustrated below. Note that the signals are attenuated by both the input and output low-pass filters, resulting in rolloffs both below and above the Nyquist frequency.

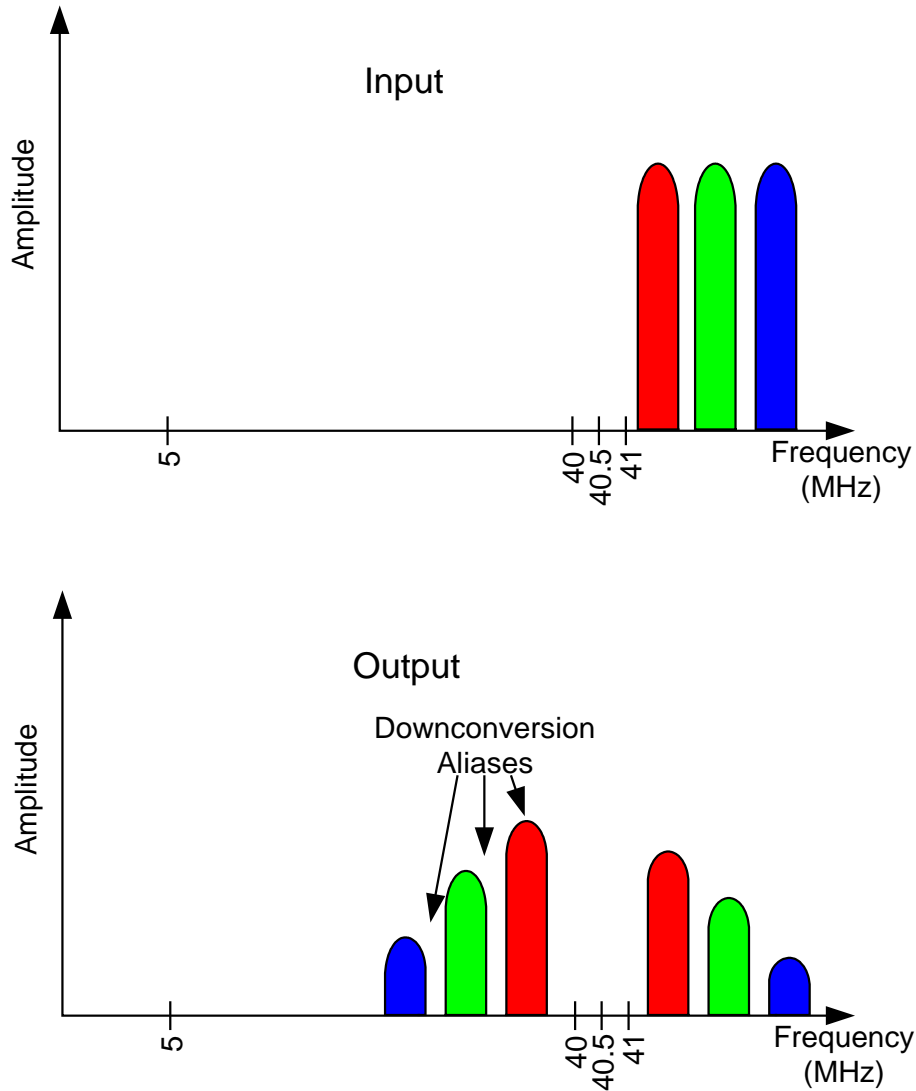

Therefore, care must be taken to ensure that no signals are applied at the input of the transmitter in the range that might result in corruption of the desired signals.

Specifically:

- For the 5-40 MHz version of the 2.5 Gb/s 4:1 bdr product, signals in the range from 42 MHz to approximately 47 MHz should not appear at the transmitter input.
- For the 7-42 MHz version of the 2.5 Gb/s 4:1 bdr product, signals in the range from 43-49 MHz should not appear at the transmitter input.
- For the 10-45 MHz version of the 2.5 Gb/s 4:1 bdr product, signals in the range

from 47-52 MHz should not appear at the transmitter input.

## Artifacts from Digital Companding

The artifact of concern resulting from digital companding is quantization noise. As explained earlier, the quantization noise in a companded system changes as a function of signal level. This change has an impact on the noise power ratio (NPR) curve. A typical NPR curve for the 2.5 Gb/s 4:1 bdr product is shown below.

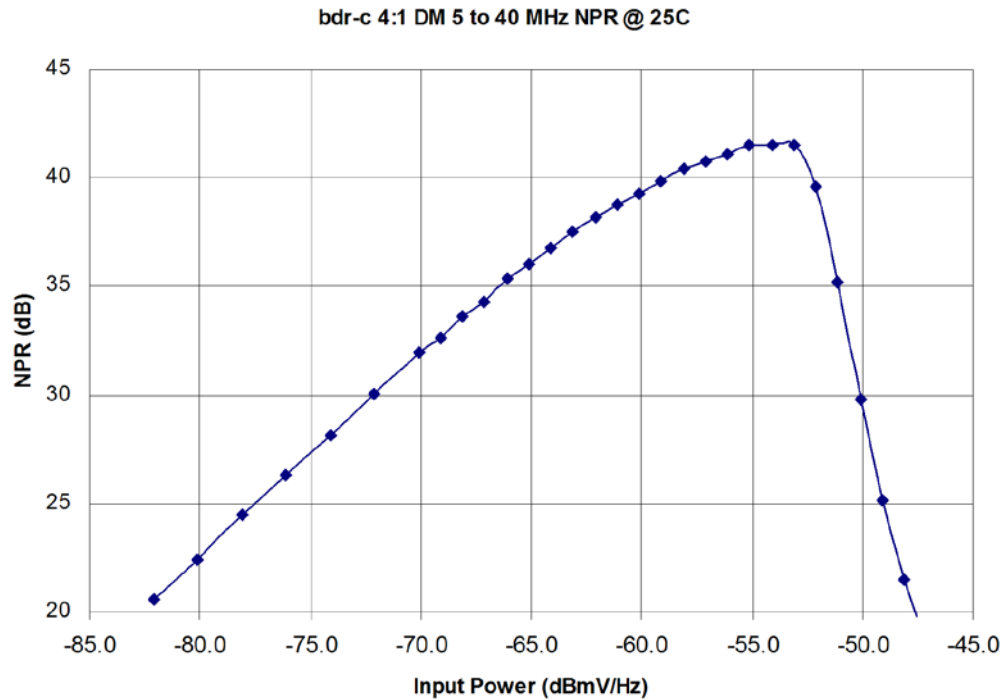

## Conversion Artifacts

An alternate way of presenting the information in the left half of the NPR curve is shown below. This graph shows quantization noise changes as a function of input level.

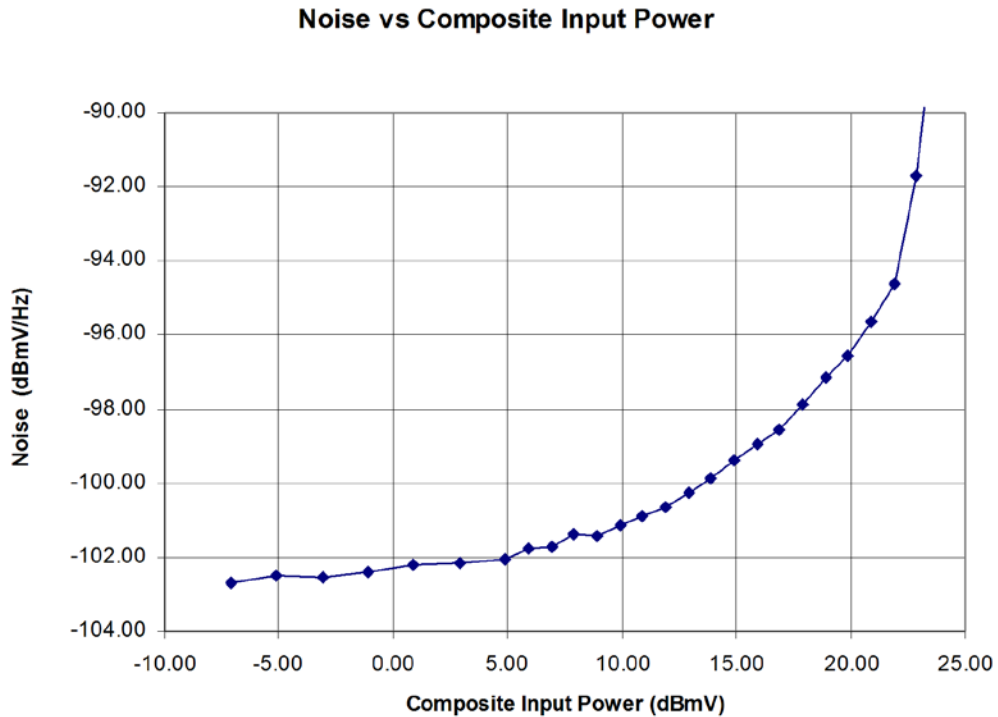

At composite input levels above approximately 22 dBmV, noise is dominated by clipping distortion. Below 22 dBmV, however, noise results mainly from quantization error, *not from distortion or clipping*. As shown in the graph above, the quantization noise floor changes around 7 dB, from roughly -102 dB to -95 dB, as the composite input level is increased from -5 dBmV to +22 dBmV. This quantization noise results from the variation in individual step size in the A/D-D/A transfer characteristic.

As the loading on an individual link changes, the quantization noise floor changes. Understanding this characteristic is critical in predicting how overall system performance will be affected as multiple links are combined.

## Conclusion

Prisma II 2.5 Gb/s 4:1 bdr products employ a combination of DSP techniques to effectively double the signal capacity of the reverse path. These techniques produce artifacts and noise which, though measurable, do not adversely affect performance when suitable precautions are taken.

Artifacts in the 41-47 MHz may appear as a result of input signals at the transmitter in the range of 34-40 MHz. These may be disregarded as they do not represent additional loading of the bdr link.

Care must be taken to ensure that no signals are applied at the input of the transmitter in the range that might result in corruption of the desired signals. Specifically:

- For the 5-40 MHz version of the 2.5 Gb/s 4:1 bdr product, signals in the range from 42 MHz to approximately 47 MHz should not appear at the transmitter input.
- For the 7-42 MHz version of the 2.5 Gb/s 4:1 bdr product, signals in the range from 43-49 MHz should not appear at the transmitter input.
- For the 10-45 MHz version of the 2.5 Gb/s 4:1 bdr product, signals in the range from 47-52 MHz should not appear at the transmitter input.

Below 22 dBmV composite power at the transmitter input, noise in the bdr output is mainly due to quantization noise in the A/D-D/A transfer characteristic. As the loading on an individual link changes, the quantization noise floor changes. Noise floor degradation may affect system performance as multiple links are combined.

For Information

## For Information

### Support Telephone Numbers

If you have technical questions, call Cisco Services for assistance. Follow the menu options to speak with a service engineer.







Cisco Systems, Inc.  
5030 Sugarloaf Parkway, Box 465447  
Lawrenceville, GA 30042

678 277-1120  
800 722-2009  
[www.cisco.com](http://www.cisco.com)

Cisco and the Cisco logo are trademarks or registered trademarks of Cisco and/or its affiliates in the U.S. and other countries. To view a list of Cisco trademarks, go to this URL:

[www.cisco.com/go/trademarks](http://www.cisco.com/go/trademarks)

Third party trademarks mentioned are the property of their respective owners.

The use of the word partner does not imply a partnership relationship between Cisco and any other company. (1110R)

Product and service availability are subject to change without notice.

© 2006, 2008, 2012 Cisco and/or its affiliates. All rights reserved.

October 2012 Printed in USA

Part Number 78-4016548-01 Rev C